

25	Washer for cam insert	1	Polyacetal	-	-
24	Middle spring	2	Spring Steel Grade 3	-	Epoxy Powder Coated
23	Inner spring	2	Spring Steel Grade 3	-	Epoxy powder coated
22	Outer spring	2	Spring Steel Grade 3	-	Epoxy powder coated
21	Stoke adjustment screw	2	HGA Steel	12.9 Grade	Zinc passivation
20	Piston bearing	2	Polyacetal	-	-
19	Washer	1	AISI304	-	-
18	Washer	2	AISI304	-	-
17	O ring	2	NBR	-	-
16	Hex socket screw	8	AISI304	-	-
15	Piston Seal	2	Polyethylene	-	-
14	Pinion Seal	1	Polyethylene	-	-
13	Pinion Seal	1	Polyethylene	-	-
12	Lock nut	2	AISI304	-	-
11	Cover seal	2	NBR	-	-
10	Cam insert	2	Cast Carbon Steel	ASTM A216 Grade WCB	Electroless nickel plated
9	Pinion bearing	1	Polyacetal	-	-
8	External Circlip	1	Spring Steel	DIN471(1S3075)	Nickel plated
7	Washer	1	Polyacetal	-	-
6	Piston bearing	1	Polyacetal	-	-
5	Pinion bearing	1	Polyacetal	-	-
4	Pinion	1	Steel	EN-8	Electroless nickel plated
3	Piston with Rack	2	Aluminium	LM6	-
2	Cover	2	Aluminium	LM6	Epoxy powder coated
1	Body	1	Aluminum Alloy	6063T6	Hard anodized
NO	PART DESCRIPTION	QTY	MATERIAL	SPECIFICATION	CORROSION PROTECTION

This drawing is property of Rotex Controls Inc. this drawing contains confidential information of Rotex Controls Inc., It must not be disclosed to third party, competitors or copied or lent without the written consent of Rotex Controls Inc.

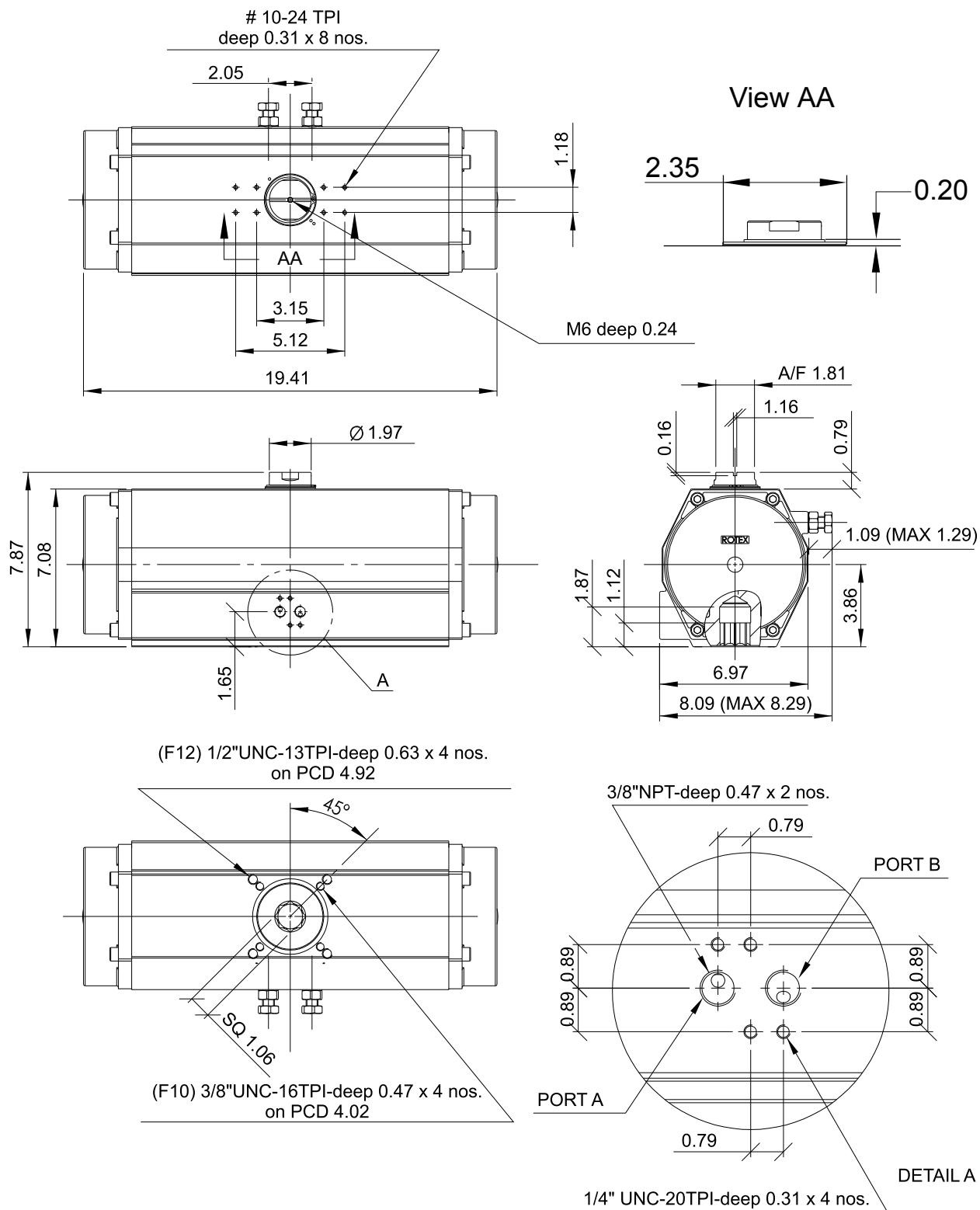

Pinion inches	Min	Max	Pinion mm	Min	Max
1.06	1.063	1.068	27.0	27.02	27.13

This drawing is property of Rotex Controls Inc. this drawing contains confidential information of Rotex Controls Inc., It must not be disclosed to third party, competitors or copied or lent without the written consent of Rotex Controls Inc.